

'AF' SLIDER DOOR FITTING INSTRUCTIONS

(Recess Installation)

1. Fit the shower tray ensuring it is level across all areas (Fig 1).

Apply silicone sealant to the edges of the tray before and after tiling.

2. Assemble the frame by fixing the top & bottom rails to the fixed glass panel by first sliding the glass clips into the groove in the top & bottom rails with the open end facing outwards (Fig 2). Then slide the glass seal into the groove until it is fully home and retained under the glass clip (Fig 3). Place the end caps on either ends of the rails making sure to snap out the top bar (Fig 4) (Sketch A) of the end cap at the glass ends only.

Then push the glass fixed panel into the seals in the top & bottom rails (Fig 5) and fix by screwing through the aluminium posts into the rails using the 40mm screws (Fig 6).

ENSURE THAT ANY LOGO IS TO THE INSIDE OF THE ENCLOSURE.

4. Fit the side rail to the open side of the frame ensuring that the channel for the magnetic strip is on the inside of the enclosure and fix in position using the 40mm screws to secure the frame (Fig 7).

5. Fit the rubber door stops using the 10mm round headed screws (Fig 8). Take the wall posts and set 15mm in from the edge of the tray. Using a spirit level ensure that the wall posts are vertical and plumb (Fig 9). Mark the hole positions (Fig 10), remove and drill for wall plugs, then fit the plugs.

6. Slide the wall posts onto either end of the frame. Carefully, lift the frame into position and fix to the wall using the 30mm screws. Ensure that the screw collars are fitted to the screw beforehand. Taking care not to scratch the unit, mark and drill two 3.2mm holes 150mm from the top & bottom on the inside of the enclosure through the wall posts and frame (Fig 11). Secure with the 10mm screws, again ensuring that the collars are in place.

7. Fix the top wheels to the glass door ensuring the correct hand for installation by unclipping and lowering the cover cap. Undo the retaining nut and fix through the hole in the glass and re-tighten (Fig 12). Final adjustment can be made by slackening the nut when the assembly is complete.

8. Fix the bottom wheels into position by dis-assembling the wheel and placing the plastic saddle over the glass. Tighten in position through the hole in the glass. Place the spring over the spigot within the wheel housing (Sketch A) and slide the wheel onto the plastic saddle. Re-fit the cover cap (Fig 13).

9. Hang the doors onto the top rail making sure that the wheels are located in the channel (Fig 14). Then from the outside, push down on the spring loaded wheels and clip into position (Fig. 15).

10. Cut to length the magnetic jointing strips and seal. Slide the magnetic strip into the side rail (Fig 16) and clip the magnetic seal onto door ensuring that the offset marries up with the magnetic strip (Fig 17).

11. Cut to length the two vertical water seals and clip into position on the glass doors and glass side panels (Fig 18).

12. Finish by fitting the handles, decorative caps supplied and apply silicone down the vertical edges of the wall channel, and the bottom edge between the bottom rail and tray. (Fig 19/20).

DO NOT SEAL THE ENCLOSURE ON THE INSIDE OF THE ENCLOSURE!

Fig. 1



Fig. 2

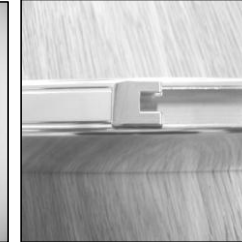

Fig. 3

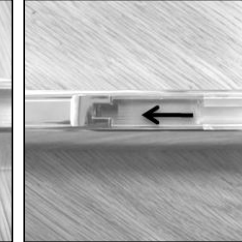

Fig. 4

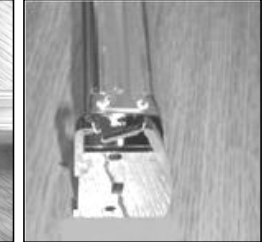

Fig. 5



Fig. 6

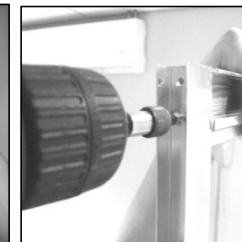

Fig. 7



Fig. 8

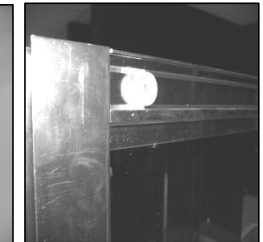

Fig. 9



Fig. 10

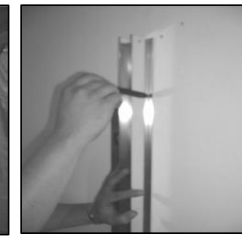

Fig. 11

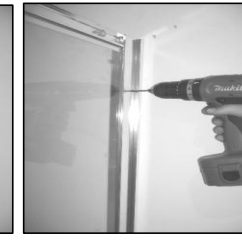

Fig. 12

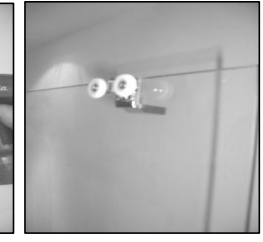

Fig. 13

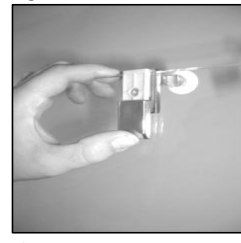

Fig. 14



Fig. 15

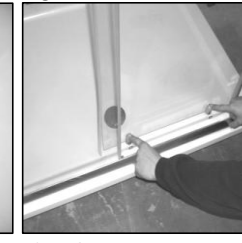

Fig. 16



Fig. 17



Fig. 18



Fig. 19

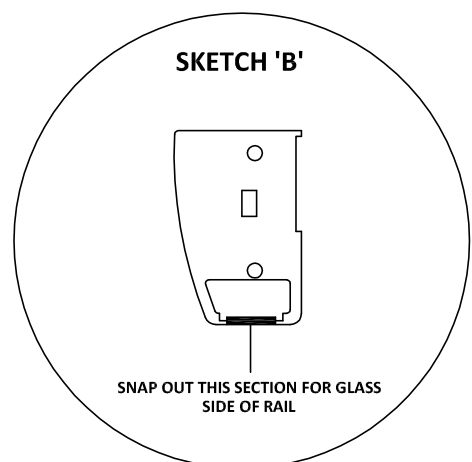
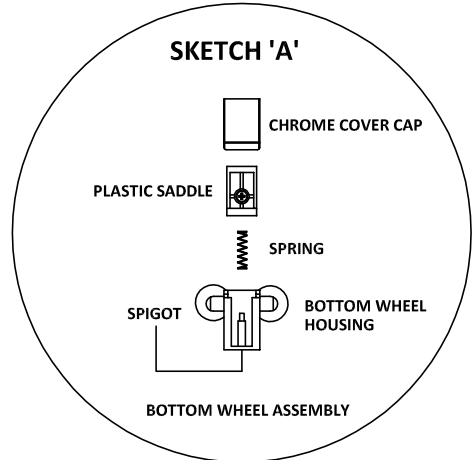
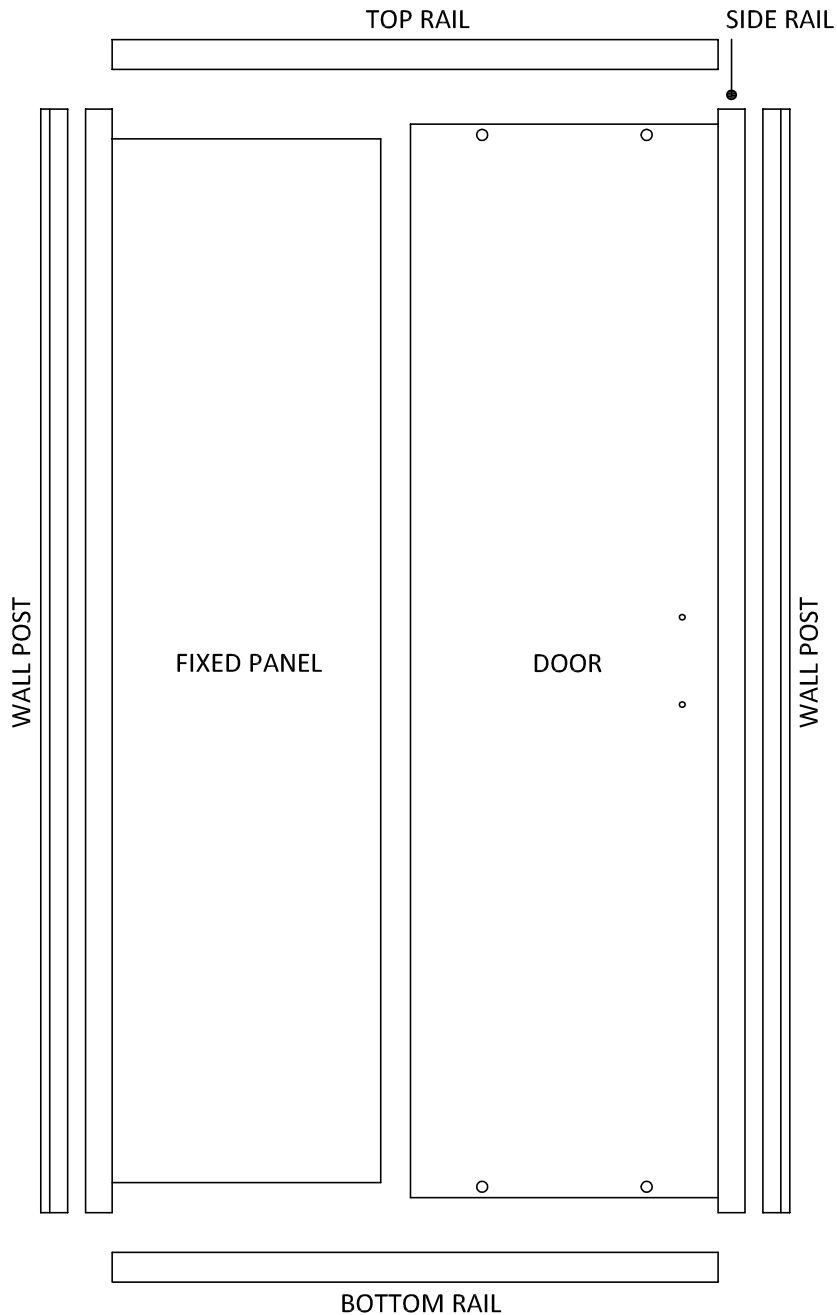

Fig. 20



AF SLIDING DOOR FITTING INSTRUCTION

WHEN A SLIDING DOOR IS TO BE FITTED WITH A SIDE PANEL, PLEASE REFER TO THE SIDE PANEL INSTRUCTION IN CONJUNCTION WITH THESE.



AF SLIDER PARTS LIST		
	MAGNETIC STRIP	1
	MAGNETIC SEAL	1
	VERTICAL SEAL	2
	GLASS SEAL	2
	SCREW COLLAR	10
	SCREW COVER CAPS	10
	GLASS CLIP	2
	RUBBER DOOR STOP	2
	WALL PLUGS	6
	40mm SCREWS	8
	30mm SCREWS	6
	10mm SCREWS	6
	BOTTOM WHEEL ASSEMBLY	1
	TOP WHEEL ASSEMBLY	1
	TOP AND BOTTOM RAIL END CAPS R/H	1
	TOP AND BOTTOM RAIL END CAPS L/H	1
	WALL POST COVER CAPS	2
	DOOR HANDLE	1