

UNIVERSAL LEG SET & PANEL KIT

Thank you for purchasing our tray. Please fully read these installation procedures and familiarise yourself with the components before commencement.

Please inspect the product immediately and fully upon receipt and prior to installation for transit damage, or any defects. Damage or defects reported later cannot be accepted.

Your tray comes with a protective film. Peel back to inspect then replace.

Do not discard the packaging as some of it is utilised through out the installation procedures.

Assembly of the Universal Leg Set & Panel Kit

For the best results & ease of installation determine the waste position of the tray.

Place the tray in the desired position or best location to simplify the installation.

The tray can be rotated indexing the waste to the most suitable position.

Fit the waste assembly & exit pipe work (following the waste manufacturers instruction & advice)

Place the tray face down on a protective surface or packaging.

See over the page and check your size & type of product.

Align the legs and panel clips to the diagram overleaf which suits your product.

Your tray is supported by a new reinforcement material with the ability to screw into.

Secure each leg with x3 (13mm) 1/2" x No8 round headed screws provided.

Under no circumstances use a longer screw for fixing into the base.

Adjust the leg so that the overall assembly is a 100mm to suit the panel location and lightly tighten the hexagonal nut.

Depending on which leg clip has been supplied, screw the panel clips to the underside of the tray as illustrated overleaf. **It is important that the correct screw size is used for this operation.**

We recommend that the metal clip is fitted so that it overhangs the tray 4mm.

The plastic clip should be fitted to suit the panel return depth as this may vary.

Note! When moving your tray into position, do not slide as this can loosen the leg fixings.

In most cases, your plastic panel(s) is supplied over length.

Place onto the clips following the contour of the product if applicable.

Mark the panel to length at each end & cut accurately to length with a fine toothed saw.

Remove the panel.

Turn over the tray & adjust the adjustable feet to level the tray. Fit the panel which is 100mm in height into its desired location.

Check with a spirit level that the tray is correctly levelled and fully tighten the hexagonal nuts on the legs.

Scribe a line on the floor where the panel will sit.

Fit to the floor behind the scribed line taking account of the panel return lip. Fit several small blocks of wood (not supplied) to ensure the panel remains stable.

It is recommended that the legs at the front of the tray are screwed to the floor.

Special care should be taken when using power tools & when drilling take care to avoid hidden pipes or electrical cables.

Make all waste connections & after tiling seal the tray along the contact edges.

Check for water tightness and finally fit the panel(s)

SQUARE TRAYS

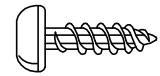
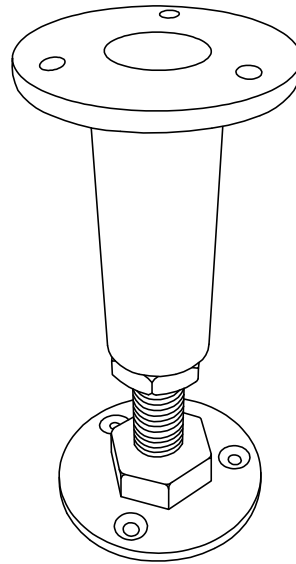
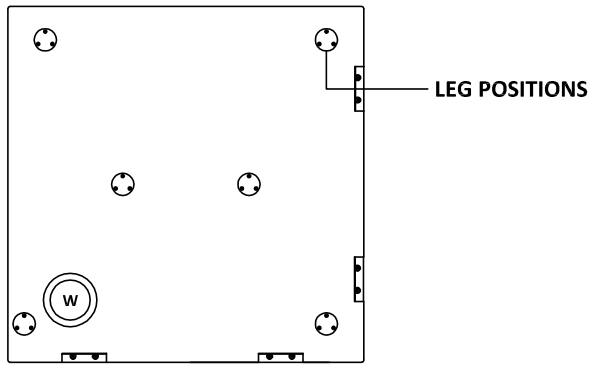

SCREWS 1/2" x No 8 RH (x18)

EQUAL QUADRANT TRAYS

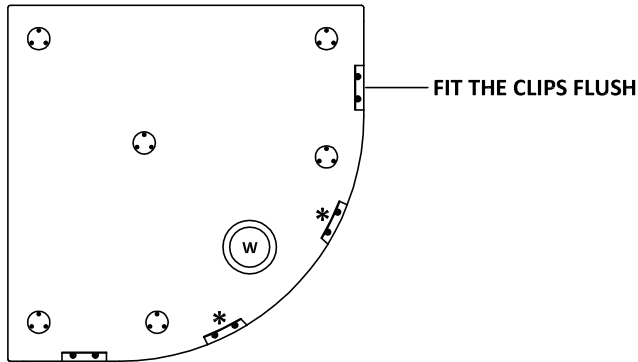

ADJUSTABLE FOOT (x6)

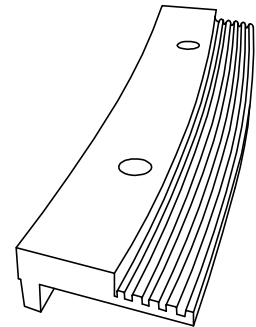
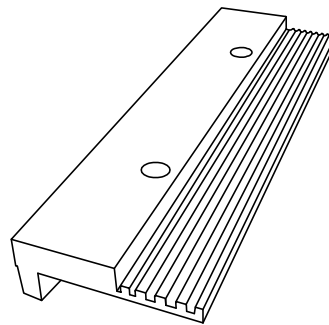

STRAIGHT PANEL CLIPS (x4)

*** CURVED PANEL CLIPS (x2)**

OFFSET QUADRANT TRAYS

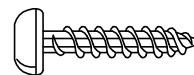
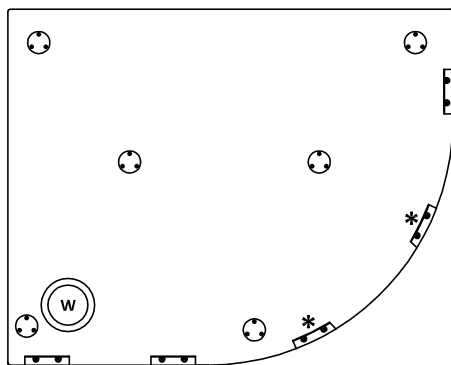

SCREWS 1" x No 8 RH (x12)

RECTANGULAR TRAYS

Length 1000, 1100 & 1200mm Long

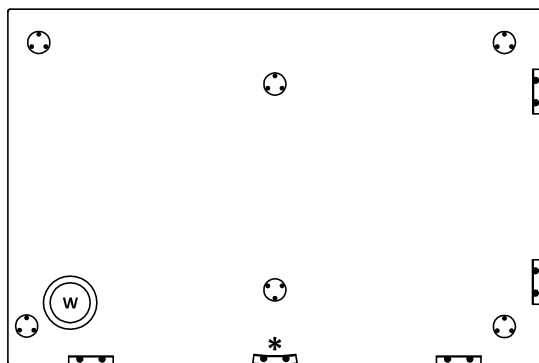

LARGE RECTANGULAR TRAYS

Length 1400, 1500, 1600 & 1700mm Long

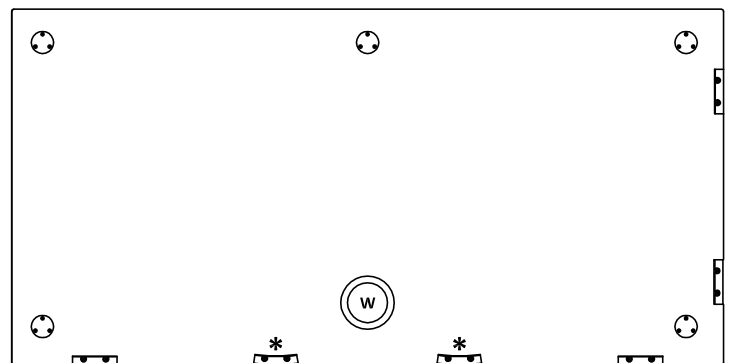

ON RECTANGULAR TRAYS, ENSURE THE PANEL CLIPS ARE FITTED TO THE SIDE REQUIRING PANELS. THIS IS DEPENDENT ON THE WASTE POSITION.